

SPECIFICATIONS / TECHNICAL DATA

ALUMINUM MEDICINE CABINET

24" x 36"

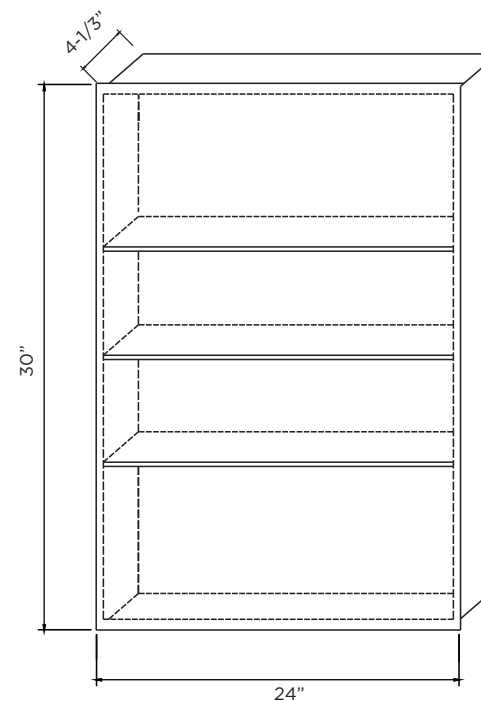
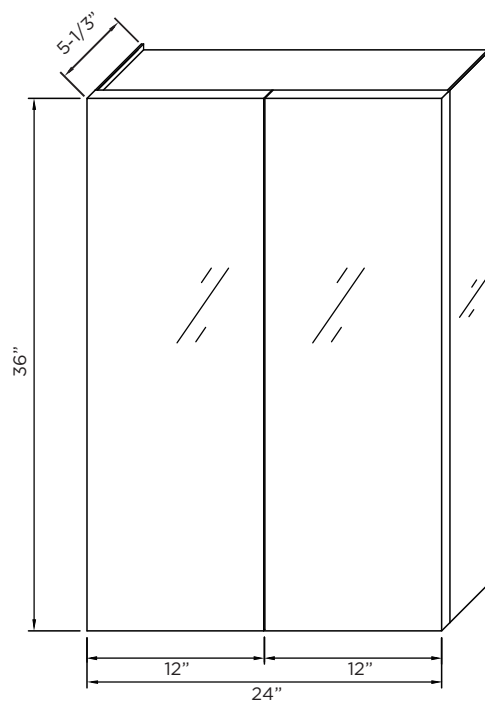
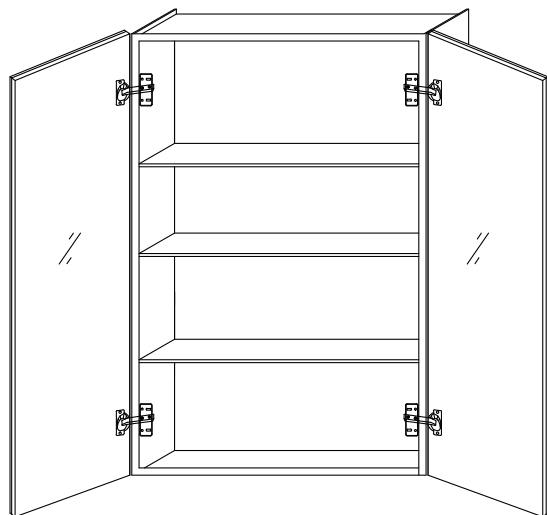

ATTENTION! Dimensions may vary by up to 3/8". It is highly recommended to pull all dimensions of actual model for installation and measuring purposes.

MODEL# AMA2436